

# hermitage

Radiant and striking, the Hermitage is furnished to inspire. Characterised by refined artistic shapes, the sculptural forms add glamorous and dramatic personality to your interior.

## Small Rose

- 8170 .....Lever Set
- 8170LD ...Dummy Lever - LH
- 8170RD...Dummy Lever - RH
- 8256 .....Passage Set
- 8257 .....Privacy Set
- 8259 .....E85 Entrance Set

- > **Lever Set**  
Includes Levers only
- > **Passage Set**  
Includes Levers and 1172 Tubular Latch
- > **Privacy Set**  
Includes Levers, 1172 Tubular Latch, 1173 Privacy Bolt and 8188 Privacy Turn & Release Set
- > **Entrance Set E85**  
Includes Levers, 1143 Euro 85 Lock, 1148 Cylinder and 8189 Euro Escutcheons

# ITALIAN



## Dimensions

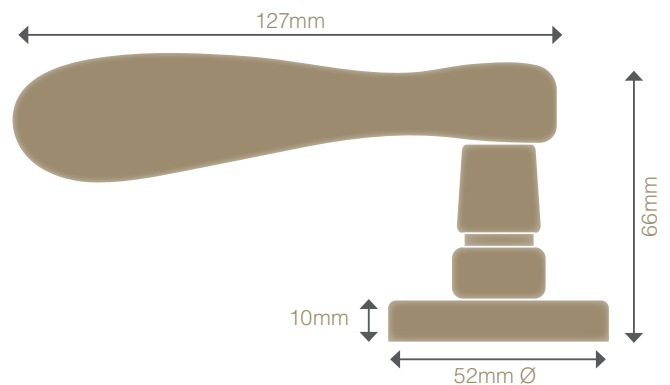
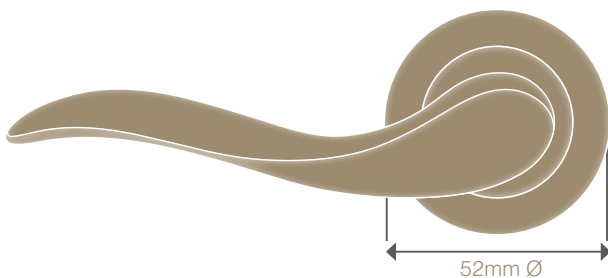

### Specs

- > Constructed from solid brass
- > Suits door thicknesses of 30–50mm
- > For door thicknesses that exceed this, custom spindles and alternative fixings will need to be sourced
- > Suitable for interior and exterior use (advise application on order)
- > For external applications we recommend selecting a living finish that will age gracefully over time instead of a lacquered finish that may tarnish if it gets badly scratched or damaged.

### Installation

- > 57mm backset (see diagram)
- > 42mm screw centres — Thru fixing supplied
- > Passage Set installation shown (used with Windsor 1172 Tubular Latch)
- > Inside hole can be 22–25mm diameter
- > Through Screw holes can be drilled at 3 & 9 o'clock **OR** 12 & 6 o'clock positions.

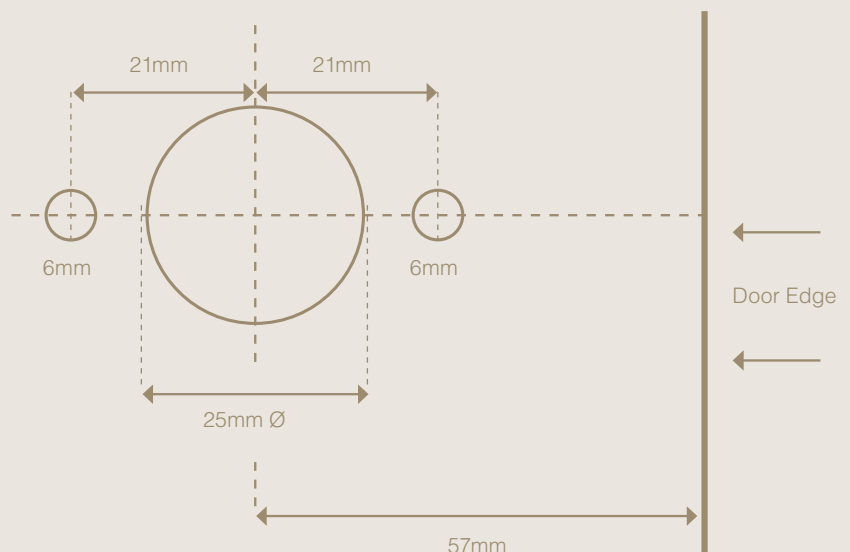
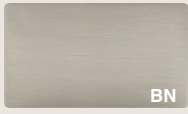

Diagram is not to scale, please refer to fitting instructions [here](#).

## Finishes

### Stocked



BN  
Brushed Nickel



SC  
Satin Chrome

### Living

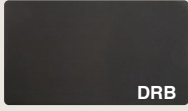

DRB  
Dark Roman Brass

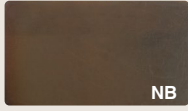

NB  
Natural Bronze



OR  
Oil Rubbed Bronze



RB  
Roman Brass

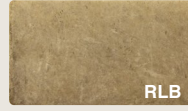

RLB  
Rumbled Brass

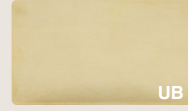

UB  
Unlacquered Brass

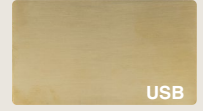

USB  
Unlacquered Satin Brass

### Lacquered

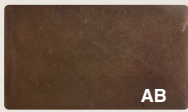

AB  
Antique Bronze

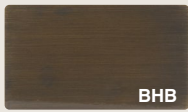

BHB  
Brushed Bronze

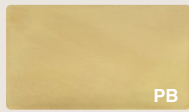

PB  
Polished Brass



SB  
Satin Brass

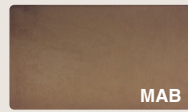

MAB  
Matt Antique Bronze

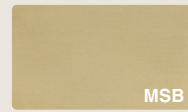

MSB  
Matt Satin Brass

### Matt Lacquered

### Powdercoat

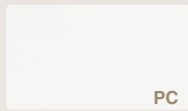

PC  
Powdercoat

> Colours are from the Dulux range

To view this handle style in each finish option, visit our [website](#) and enter any product code listed on page 1 of this document.

## Care & Maintenance

### Stocked Finishes

To protect your handles we suggest cleaning the surface of your hardware periodically with a warm soapy lightly dampened cloth to remove any build-up of dust and grime that may cause corrosion and affect the integrity of the finish. Then simply dry thoroughly with a clean, soft cloth. Minimum of monthly cleaning of door handles is recommended for both finish preservation and general hygiene.

Atmospheric conditions, salt deposits, acids, caustic agents, cement or dust on construction sites all have the potential to cause discolouration to the surface.

Please avoid using any metal polishes, abrasive cleaners, scorers or rough cloths that may damage or scratch the hardware and do not spray or immerse the hardware in liquid to clean.

### Living Finishes

The living finishes will naturally patina over time with general use. As with all living and aging finishes, it is recommended to clean the surface periodically with a damp soapy cloth to remove any build up of dust and grime that may cause corrosion and affect the integrity of the finish.

Unlacquered Brass can be further protected by using the Windsor wax polish occasionally, rubbing this lightly over the surface will provide a layer of protection for extended finish longevity.

Oil Rubbed Bronze, Roman Brass and Dark Roman Brass can be preserved by gently applying a thin oil layer to the surface from time to time. Wipe a thin layer of olive oil (or similar) over the handle then with a clean cloth wipe again to remove any excess on the surface.

### Lacquered Finishes

The finishes with a lacquer are recommended to be kept free of dust and grime to prevent any chance of these particles affecting the integrity of the lacquer and potentially causing breakdown or discolouration. We suggest these are wiped and cleaned periodically using a mild window cleaner and damp cloth.

Gloss Lacquered finishes may get some light surface scratches appearing with normal wear and tear, for this we recommend using the Windsor wax polish occasionally, rubbing this lightly over the affected area to will provide a layer of protection for extended finish longevity.

We do not recommend Lacquered Finishes to be used externally as if badly scratched or damaged tarnishing can occur.